

IndustrialIT
enabled™

- **Large clear display**
 - 31cm (12.1 in.) thin film transistor (TFT) color screen
- **Unsurpassed environmental protection**
 - hosedown to IP66 and NEMA4X standards
- **Multiple point recording**
 - up to 36 universal analog inputs
- **Robust and convenient archive storage**
 - solid-state high-reliability SmartMedia and Compact Flash memory card options
- **Intuitive user interface**
 - clear and simple Windows-style operation and configuration menus
- **10BaseT Ethernet communications as standard**
 - easy integration into PC networks
 - remote monitoring/access
- **21 CFR Part 11 compliant data security**
 - extensive physical and electronic security features

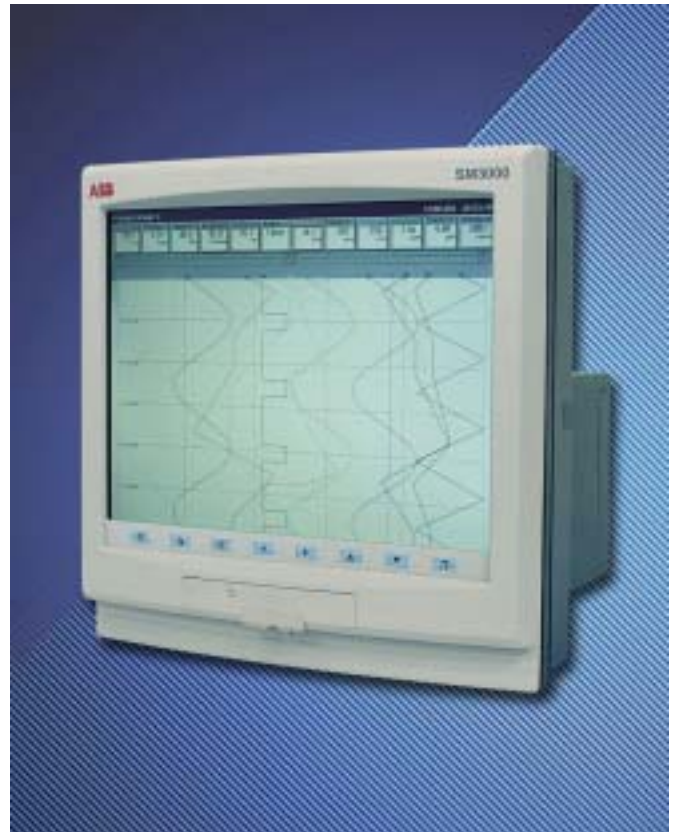

**Raising the Standards
of Data Storage**

SM3000

The SM3000 Multipoint Videographic Recorder features state-of-the-art data storage and security technologies. Up to 36 universal analog inputs, communicated inputs or math results can be recorded and displayed in a variety of operator views.

Standard 10BaseT Ethernet communications ensure full integration into PC networks for remote process monitoring and secure access to archived process data.

8Mb of onboard flash memory, capable of storing 2.8 million samples of data and the option of either SmartMedia or Compact Flash removable memory cards (with capacity up to 128Mb), provide extensive data storage capability.

A bright, clear high-contrast 31cm (12.1 in.) TFT display, Windows-style operation and configuration menus ensure clear and simple operator interface.

Application areas include:

- Environmental monitoring
- Water treatment plants
- Heat treatment
- Autoclaves
- Food, Dairy and Beverage processing
- Power Stations
- Cold storage
- Emission monitoring

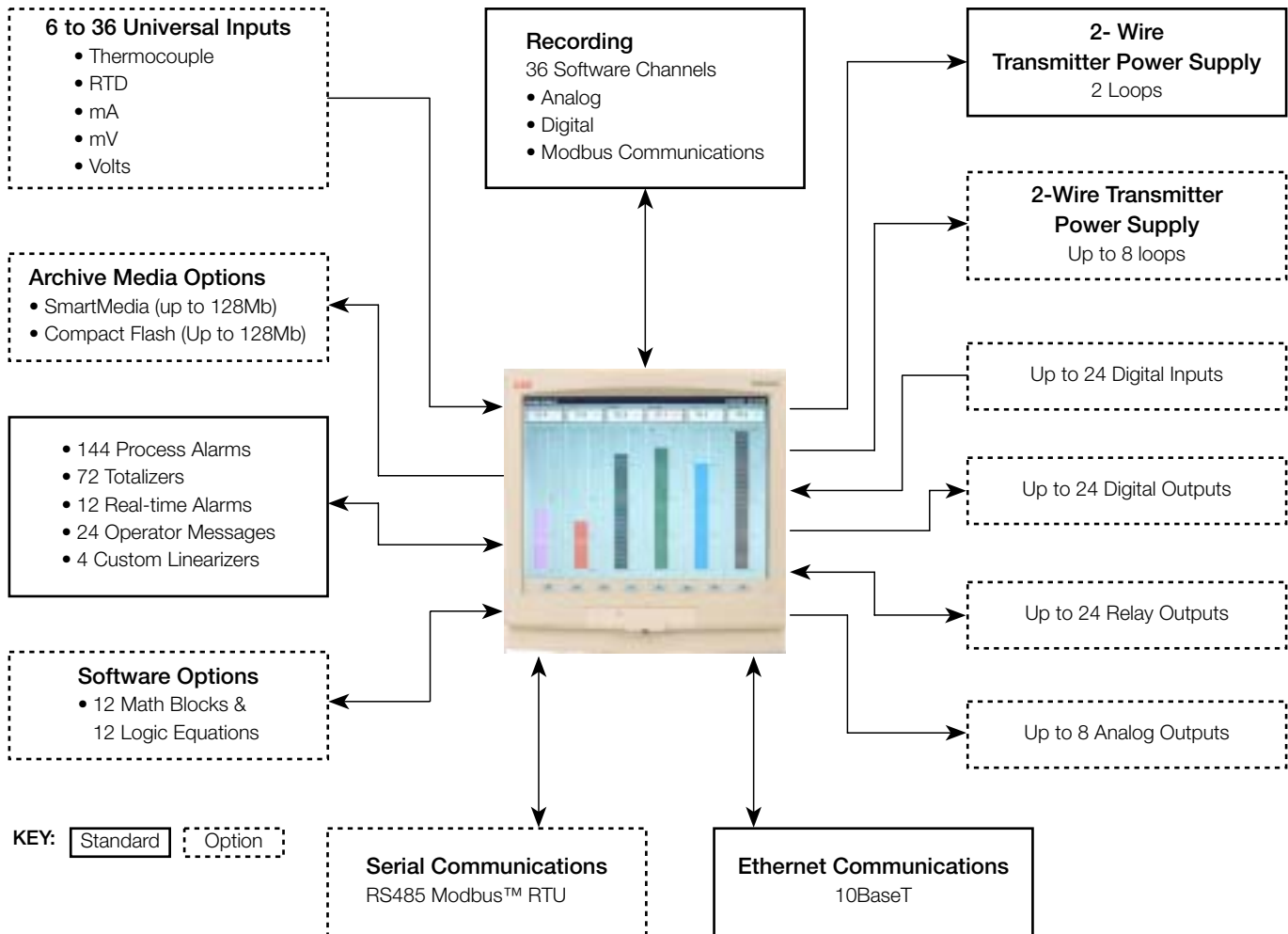

Advanced Process Recording

- 36 recording channels are provided as standard which can be used to record any analog, digital or communications (via Modbus) signal.
- Each group can be stored at it's own primary or secondary sample rate. This allows detailed information to be stored under specific process conditions, e.g. critical process states or alarm conditions. Alternatively, for simple applications one sample rate can be applied to all channels.
- Through the use of pre-storage filters it is possible to record the average, max./min. or instantaneous values of any recording channel.
- 8Mb of internal memory is provided for buffering of process data. Once this memory is full it wraps-around automatically and overwrites the oldest data, ensuring that the latest process data is always captured.
- All data recorded by the SM3000 is available to archive to the removable storage media. During periods when a card is not present or is full, data is still recorded into the SM3000's internal memory. When a card is inserted or space becomes available on the card unarchived data can be transferred to the card.

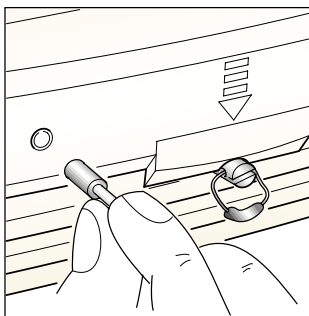
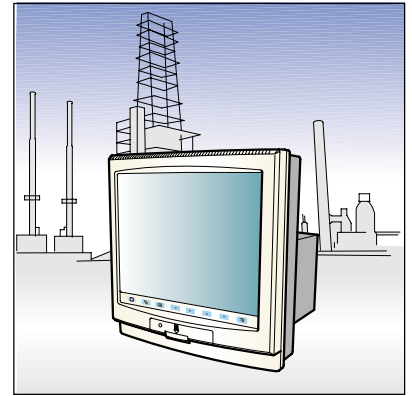

Security

- High specification data security compliant with 21 CFR Part 11.
 - A media door lock is fitted as standard to prevent unauthorized access to the memory card.
 - Multiple users can be configured, each with an individual user name and password. Comprehensive security options, including password expiry and configurable access levels, ensure the exceptional security of the SM3000.
 - Operator actions, data archiving events, configuration changes and other system occurrences are all saved to the audit log of the SM3000. Each entry is time, date and, where appropriate, stamped with a user ID, providing a comprehensive audit trail to accompany any data recorded by the SM3000.
- All data files contained within the SM3000's 8Mb of internal buffer memory, or created on memory cards, are encoded in a secure binary format ensuring that recorded data cannot be altered.
 - Two security modes are available for protection of the instrument's configuration. Multiple users can be configured, each with individual passwords and access levels or, as an alternative, a tamper-evident seal can be fitted to the front of the recorder. In this mode the configuration of the recorder can only be altered by first changing the position of an internal switch. To accomplish this the recorder must be removed from it's case, breaking the seal.

Guaranteed Data Integrity

- The use of Flash memory technology ensures that the SM3000 is not reliant on batteries to preserve stored data during a power failure.
- Data stored in the internal memory and on removable media is stored in small blocks with each block containing a checksum to ensure the integrity of that data.
- An advanced error detection/correction code is built into the internal Flash memory, ensuring safe storage of your process data.

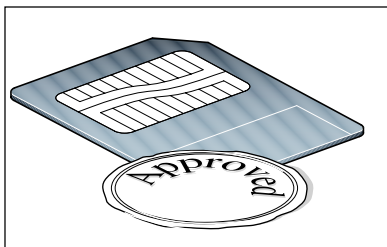
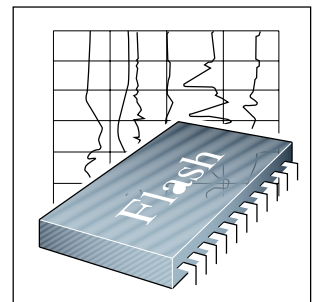

Industrial Standard, Robust, Archive Storage

- Either SmartMedia or Compact Flash memory card options can be fitted to the SM3000 for archive purposes. The solid-state nature of these devices ensures that the SM3000 can truly operate in ambient temperatures up to 50°C (122°F), whereas traditional electromagnetic floppy disk drives can operate only in temperatures up to 40°C (104°F).
- Every write to the archive storage media is verified to ensure the integrity of the data.

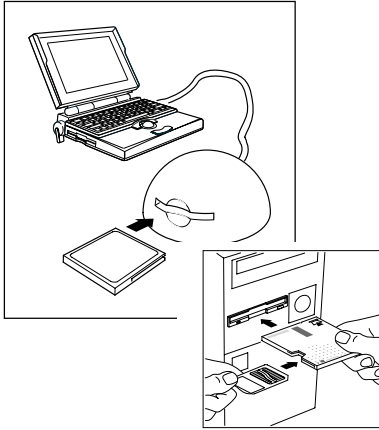

PC Interface for Archive Storage Media

Through the use of PC adapters for SmartMedia and Compact Flash, both options provide the advantages of very robust, solid-state storage with the convenience-of-use previously found only with floppy disks.

- Archives, stored on both Compact Flash and SmartMedia, can be accessed via a reader which plugs into the parallel, or USB, port of a desk/lap-top computer.
- A SmartMedia-to-floppy disk drive adapter enables SmartMedia cards to be read directly by the existing floppy disk drive on your computer.

Low Cost of Ownership

The large capacity of the SmartMedia and Compact Flash memory cards used by the SM3000 ensures that the requirement for operator intervention to transfer process data to a PC on a regular basis is greatly reduced. Older floppy disk technology, used by many other manufacturers of graphical recorders, limits storage capability significantly; sometimes to levels below the ability of a traditional paper recorder.

See below for an example of how memory storage times vary depending on the type of media device. The example shows the recording durations for a 6-channel recorder with a sample rate of 10s. Also included in the example is how these storage times compare with a traditional paper recorder.

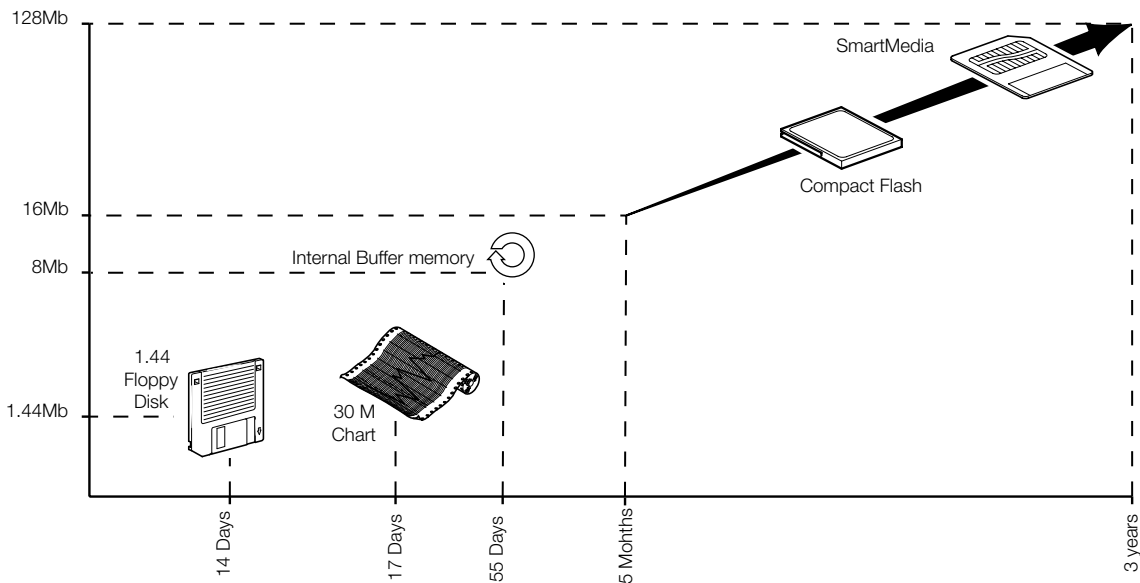



Unsurpassed Environmental Protection

Unique to this type of product, the SM3000 has unrivalled protection ratings of IP66 and NEMA4X and includes a fully-sealed, lockable media door. This enables the SM3000 to be installed, without additional protection, in applications that require frequent hosedown. With industrial standard noise emission and immunity protection, the SM3000 also operates effectively in high electrical-noise environments.

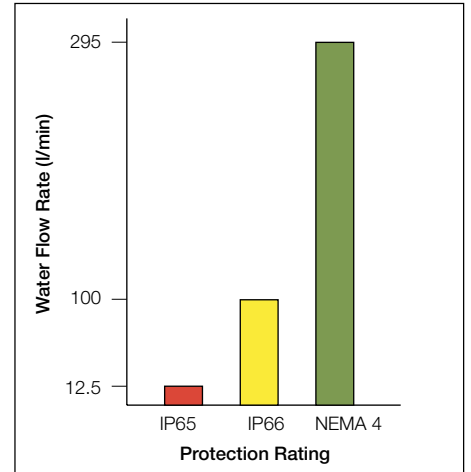

Intuitive User Interface

Alarm Status
Current Value
Process Group Name
Units
Title Bar
Status Icons
Current Date and Time
Short Channel Tag
Scale Bar
Newest Data
Screen Interval
Oldest Data
Chart Trace
Alarm Event
Time Stamp
Operator Message

Process	Press	Flow 1	Volume	Temp	Valve	Level 1	Level 2	Temp 1	Temp 2	Flow 2	
20	4.33	76.2	83.6	76.1	Close	12.1	98	227	7.40	9.74	1849
°C	l/sr	L/s	L/hrs	L		L/s	cm	cm	psf	psf	rpm

Group Key
Selects between process groups and historical logs

View Key
Selects between enabled views for the selected process groups/logs

Menu Key
Displays a pop-up menu for operator selections

Left/Right Cursor
Used to navigate Configuration & review dates in historical review mode

Up/Down Arrow
Used to navigate pop-up menus and review data in historical review mode

Enter
Used for confirming menu selections



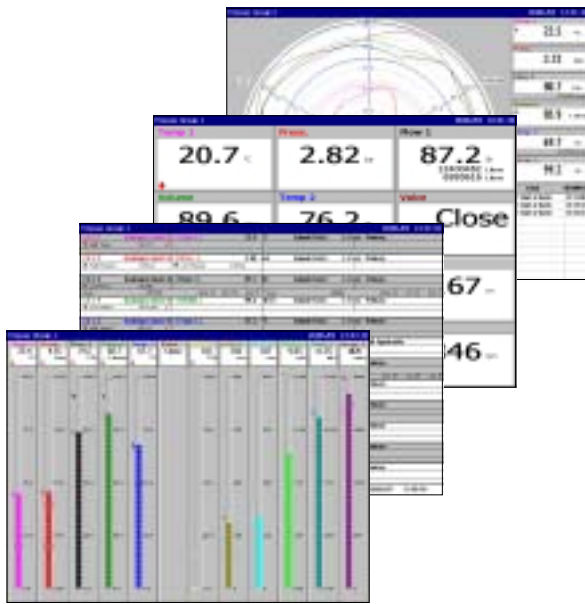

Operator Views

The 36 recording channels of the SM3000 can be freely distributed between 6 process groups and displayed using a number of different operator views. In addition to the standard strip chart views, the following views are available:

Circular Chart View

Up to six trends can be plotted on a circular chart. In addition to digital indicators, including alarm status and totalizer values, a log is constantly in view showing a list of recent alarm activity.

Digital Indicator View

Process value, engineering units, channel tag, totalizers and alarm status are all displayed clearly. An overview screen provides an at-a-glance view of all 36 recording channels.

Process View

Provides an at-a-glance summary of each channel, including detailed alarm, totalizer and statistical (min., max. & average) information.

Bargraph View

Horizontal or vertical formats, including min./max. and alarm trip point markers.



Historical Logs

Providing functions unavailable in paper-based recorders, three full time and date-stamped historical logs ensure complete validity of the recorder and its data. Any or all of these logs can be archived to the removable memory card.

Totalizer Log

All totalizer activity, e.g. starts, stops and resets, are recorded by the totalizer log. In addition individual log intervals can be configured for each totalizer, allowing total values to be logged regularly.

Alarm Event Log

A detailed history of all alarm occurrences, including active and inactive transitions plus acknowledgement details.

Audit Log

The highly-detailed secure log of all system events gathered by the Audit Log provides comprehensive evidence of the integrity, validity and traceability of data recorded by the SM3000. Included in the log are configuration changes, data archiving events, calibration adjustments, details of remote accesses and many more key events, all marked with operator IDs where applicable.

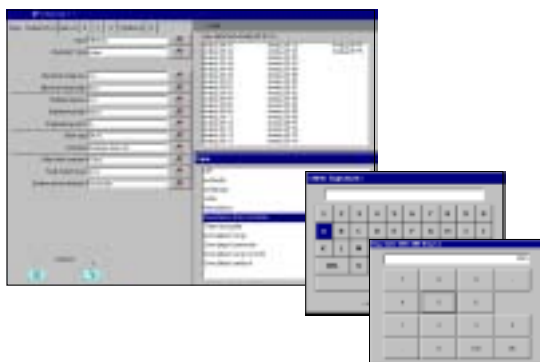

Configuration

A simple Windows-style structure provides an exceptionally easy approach to the setup of the SM3000. Text and numerical information is entered very quickly via an on-screen keyboard. Navigation of configuration menus is performed via the cursor keys and the pop-up menu.

It is also possible to configure the SM3000 via a Windows-based PC configuration package.

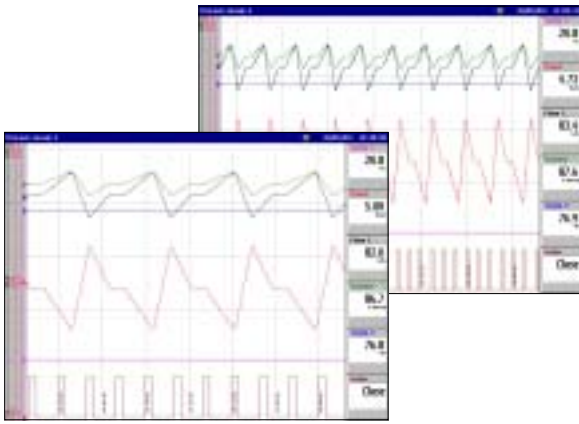

On-line Data Review

The SM3000 provides a number of unique features to provide a clear view of your process.

- The screen interval can be altered to display between 48s and 14 days of information, without it affecting the sample rate. This gives you the ability to 'zoom in' to a close-up view of the most current data or 'zoom out' to get the big picture.
- Individual traces can be temporarily removed from the screen to enable clear comparison of two or more trends.
- The SM3000 can easily review all historical data in the 8Mb internal buffer memory at the touch of a button. During this time, recording of the process data to the internal memory remains unaffected.

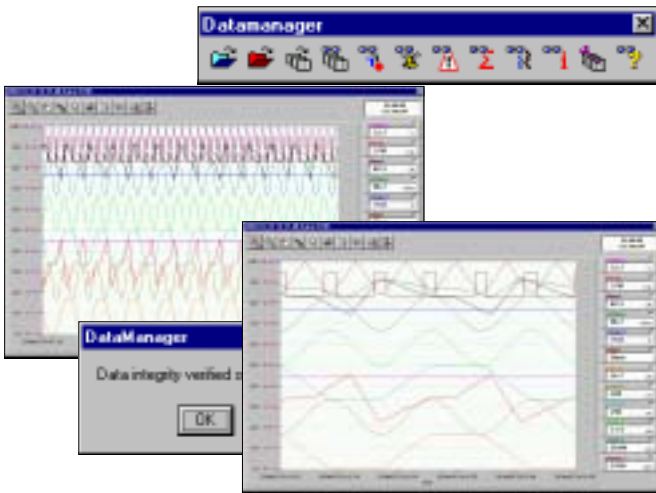

Off-Line Review and Analysis

Using ABB's DataManager software, archived process data and historical logs recorded to a removable media card can be easily reviewed.

- Database management of data files provided by DataManager ensures simple, secure long-term storage and retrieval of historical data.
- The graphing capabilities provided by DataManager ensure easy interrogation of process data.

For further information on the capabilities of DataManager, refer to data sheet SS_DATMGR.

Math and Logic

Available as an option are advanced math and logic capabilities. 12 multi-element math and 12 multi-element logic equations can be configured. Equations can be nested into each other to provide extensive capabilities.

- Mean, standard deviation and rolling averaging functions are provided.
- Standard addition, subtraction, multiplication and division are complemented with Log, Ln, Square root, power, Sin, Cos, Tan and absolute functions.
- Switching of process signals can be achieved via the high/low/mid signal selection and multiplexing functions.
- Predefined equations are provided for relative humidity and F_0 measurements.
- AND, NAND, OR, NOR, XOR and NOT operators are available within the logic equations.



All math and logic equation results can be recorded on the display of the SM3000 and archived to the removable media. Detailed diagnostic functions are provided for both the math and logic equations.

Ethernet Communications

The SM3000 provides 10BaseT Ethernet communications as standard via a standard RJ45 connector. The SM3000 uses industry-standard protocols TCP/IP, FTP and HTTP enabling easy integration into existing PC networks.

Data File Access via FTP (File Transfer Protocol)

The SM3000 features FTP server functionality that provides high-speed access via Ethernet to data archived by the recorder.

- Using a standard web-browser or other similar FTP client, data files contained within the recorder's internal memory and removable memory card can be accessed remotely and transferred to a PC or network drive.
- 8 individual FTP users can be programmed into the SM3000. Access rights can be configured for each user specifying their access level.
- All FTP log-on activity is recorded in the audit log of the SM3000.
- Using the SM series complementary FTS (File Transfer Scheduler) software, data files from multiple recorders can be backed-up automatically to a PC or network drive for long term storage, ensuring the security of valuable process data and minimizing operator intervention.

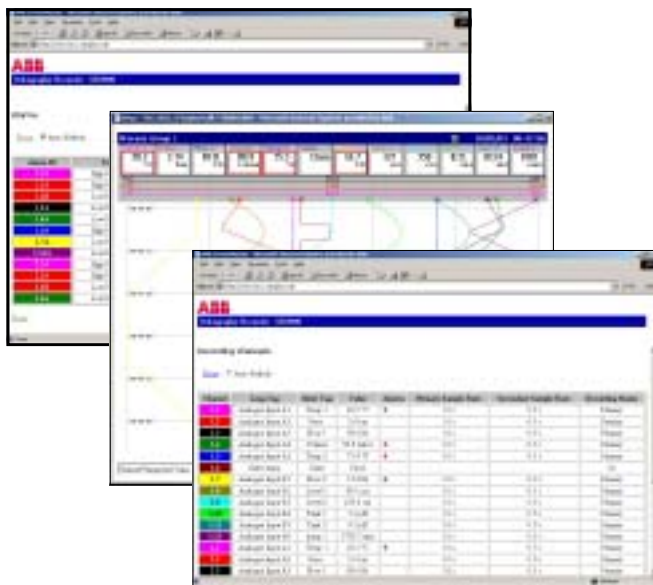
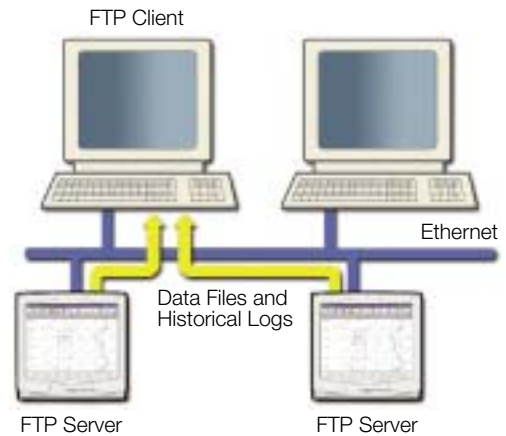

Embedded Web Server

Contained within the SM3000 is an embedded web-server, enabling access to web pages created within the recorder. The use of HTTP (Hyper Text Transfer Protocol) enables standard web browsers to view these pages.

- The web pages show the current display of the recorder, detailed information on process signals, alarm conditions, totalizer values, an overview screen showing the status of all 36 recording channels and other key process information
- The historical logs stored in the SM3000's internal buffer memory can be displayed in full from within the web pages.
- Operator messages can be entered via the web server enabling comments to be logged to the recorder.
- All of the information displayed on the web pages is regularly refreshed enabling them to be used as a process supervision tool.

Remote Access/Monitoring

Ethernet communications can provide a link to recorders installed in remote locations. By using a dial-up router, multiple SM3000 recorders can be installed in remote locations and accessed via a public telephone network when required.

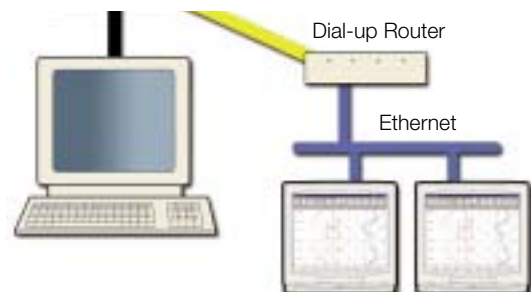

Specification

Operation and Configuration

Configuration

Via tactile membrane switches on front panel or PC Configuration using removable media card

Multiple configuration files can be stored in internal (up to 5 files) or external memory (with removable media option fitted)

Display

Thin film transistor (TFT), active-matrix, color, liquid crystal display (LCD) with built-in backlight

Low-reflective, 31cm (12.1 in.) diagonal display area, 480,000 pixel display*

Viewing angle – Horizontal 55° typ. (left side, right side)

Vertical 50° from below, 40° from above

*Note. A small percentage of the display pixels may be either constantly active or inactive. Max. percentage of inoperative pixels <0.01%.

Screensaver

Can be programmed to dim the backlight if operator keys are not pressed for a selected period of time

Languages

English (German, French, Italian and Spanish pending)

Dedicated operator keys

- Group select
- View select
- Menu key
- Left cursor
- Right cursor
- Up/Increment key
- Down/Decrement key
- Enter key

Vertical chart screen intervals

Selectable from 48s to 14 days

Horizontal chart screen intervals

Selectable from 70s to 20 days

Circular chart duration

Selectable from 9 minutes to 32 days

Chart scales

Independent primary and secondary ranges for each channel

Vertical/horizontal chart divisions

Programmable for up to 10 major and 10 minor divisions

Circular chart divisions

Programmable up to 10 divisions

Chart annotation

Alarm and operator messages may be annotated on the chart

Icons to identify the type of event, time of occurrence and tag are displayed

Operator Views

Contents	Views Available			
	Chart	Bargraph	Digital Indicator	Process
Instantaneous values/states	✓	✓	✓	✓
Units of measure	✓	✓	✓	✓
Short tags	✓	✓	✓	✓
Long tags				✓
Alarm status	✓	✓	✓	✓
Alarm trip markers		✓		
Alarm trip values				✓
Max./Min. markers		✓		
Analog bargraphs		✓		
Totalizer values & units of measure			✓	✓
Totalizer tags				✓
Max., min. and average batch values				✓
Graphical view of historical data	✓			



...Specification

Security

Configuration security

Password protection	Access to configuration is allowed only after the user has entered a password
Internal switch protection	Access to configuration is allowed only after a hardware switch has been set. This switch is situated behind a tamper evident seal

Setup security

Configuration	Can be configured for password protection or free access to setup levels
---------------	--

Users

Number of users	Up to 15
Usernames	Up to 20 characters. Usernames are unique, i.e. names cannot be repeated
Access privileges	Setup access – Yes/No Electronic signature access – Yes/No Configuration access – None/load file only/limited/full
Passwords	Up to 20 characters A minimum required password length of 4 to 20 characters can be configured and a password expiry time can be applied to eliminate password ageing
Password failure limit	Configurable for 1 to 10 consecutive occasions or 'infinite' A user is deactivated if a wrong password is entered repeatedly
Deactivation of inactive users	Can be disabled or configured for 7, 14, 30, 60, 90, 180 or 360 days of inactivity Users are deactivated (by removal of access privileges) after a period of inactivity

Electronic signature

Protection	Only accessible to users with electronic signature access privileges Access requires a valid username and password
Function	Provides an electronic equivalent to the signing of a conventional paper chart Enables operator to securely approve recorded data
Content	Date/Time, operator ID and operator defined 20-character message are stored in the alarm/event log and can be displayed on the chart

Standard Functionality

Operator Messages

Number

- 24 configurable messages of up to 20 characters each
- 1 operator defined message of up to 20 characters

Trigger

- Via front panel or digital signals

Recording in alarm/event log

- Can be enabled or disabled on configuration

Process Alarms

Number

- 144 (4 per recording channel)

Update rate

- Up to 12 alarms processed every 100ms, e.g. with 36 alarms enabled each alarm is updated once every 300ms

Types

- High/low: process, latch & annunciator, delayed process
- Rate: fast/slow

Tag

- 20-character tag for each alarm

Hysteresis

- Programmable value and time hysteresis 1 to 9999s

Alarm enable

- Allows alarm to be enabled/disabled via a digital input

Alarm log enable

- Recording of alarm state changes in the alarm/event log can be enabled/disabled for each alarm

Acknowledgement

- Via front panel or digital signals

Real-time Alarms

Number

- 12

Programmable

- Day of the week, 1st of month, start and duration times



Totalizer

Number

72 (2 per recording channel) 10-digit totals

Type

Analog or digital, batch and secure totals

Statistical calculations

Average, maximum, minimum (for analog signals)

Date and time of max. and min. values

Update rate

Up to 4 totalizers processed every 100ms, e.g. with 12 totalizers enabled each total is updated once every 300ms

Custom Linearization

Number

4

Number of breakpoints

20 per linearizer

Number of channels v. number of groups

Groups	Channels per Group
1, 2, 3	Up to 12
4	Up to 9
5	Up to 7
6	Up to 6

Recording Duration

Approximate duration calculated for continuous recording of 12 channels of analog data (for 24 channels divide by 2, for 6 channels multiply by 2 etc.)

Sample Rate	1s	10s	40s	60s	120s	480s
Internal Flash buffer memory	2 ¹ / ₂ days	27 ¹ / ₂ days	3 ¹ / ₂ months	5 ¹ / ₂ months	11 months	3 ¹ / ₂ years
Sample Rate	1s	10s	40s	60s	120s	480s
16Mb SmartMedia/Compact Flash	7 days	10 weeks	10 months	15 months	2 ¹ / ₂ years	10 years
32Mb SmartMedia/Compact Flash	15 days	5 months	20 months	2 ¹ / ₂ years	5 years	20 years
64Mb SmartMedia/Compact Flash	1 month	10 months	3 years	5 years	10 years	40 years
128Mb SmartMedia/Compact Flash	2 months	20 months	6 ¹ / ₂ years	10 years	20 years	80 years

Recording – To Internal Memory

Data Channels

Internal buffer memory

Internal Flash memory provides storage for 2.8 million samples

Oldest data is automatically overwritten by new data when memory is full

Data integrity checks

Checksum for each block of data samples

48-bit code for error detection/correction built-in

Independent process groups

6

No. of recording channels

36

Sources

Analog inputs, Modbus inputs, any digital signal

Filters

Programmable for each channel to allow recording of: instantaneous values, average, max., min. and max. & min. value over sample time

Primary/secondary sample rates

Programmable from 0.1s to 12 hours for each process group

Primary/secondary sample rate selection

Via any digital signal or from password protected menu

Recording start/stop control

Via any digital signal or from password protected menu



...Specification

Historical logs

Types

Alarm/Event, Totalizer and Audit logs

No. of records in each historical log

Up to 200 in internal memory

Oldest data is automatically overwritten by new data when log is full

Historical Logs

Log Type	Alarm/Event Log		Totalizer Log		Audit Log	
Information Recorded in Logs Log Entry Events	<ul style="list-style-type: none"> Alarm state changes Operator messages Electronic signatures 		<ul style="list-style-type: none"> User defined logging intervals Totalizer stop/start, reset, wrap Power up/down 		<ul style="list-style-type: none"> Configuration/calibration changes System events Errors, operator actions 	
	In Log	On Screen	In Log	On Screen	In Log	On Screen
Date & time of event	✓	✓	✓	✓	✓	✓
Type of event	✓	✓	✓	✓	✓	✓
Tag	✓	✓	✓	✓		
Source tag	✓		✓			
Alarm trip value & units of measure	✓					
Alarm state	✓	✓				
Alarm acknowledgement state	✓	✓				
Operator ID	✓				✓	✓
Description					✓	✓
Batch total and units of measurement			✓	✓		
Max., min. and average values plus units			✓	✓		
Secure total			✓			
Time & date of min./max. values			✓	✓		

Archiving – To Memory Card

Removable storage media options

- None
- SmartMedia (3.3V only)
- Compact Flash

File types that can be saved to removable media

- Recorded data for each channel
- Alarm event log for each group
- Totalizer log for each group
- Audit log
- Configuration

File structure

Binary encoded with built-in data integrity checks

Automatic updating of archive files

- At regular time intervals according to the sample rate
- When a media card is inserted

Data verification

Carried out automatically on all writes to removable-media files



Analog Input Modules

General

Number of inputs

6 per board, max. of 36 inputs

Input types

Milliamps, millivolts, voltage, resistance, THC, RTD

Thermocouple types

B, E, J, K, L, N, R, S, T

Resistance thermometer

PT100

Other linearizations

\sqrt{x} , $x^{3/2}$, $x^{5/2}$, custom linearization

Digital filter

Programmable 0 to 60s

Display range

-999 to 9999

Common mode noise rejection

>120dB at 50/60Hz with 300 Ω imbalance resistance

Normal (series) mode noise rejection

>60dB at 50/60Hz

CJC rejection ratio

0.05 $^{\circ}$ C/ $^{\circ}$ C

Sensor break protection

Programmable as upscale or downscale

Temperature stability

0.02%/ $^{\circ}$ C or 2 μ V/ $^{\circ}$ C

Long term drift

<0.2% of reading or 20 μ V annually

Input impedance

>10M Ω (millivolts inputs)

500k Ω (voltage inputs) externally mounted divider

10 Ω (mA inputs) externally mounted on terminals*

*Hart transmitters require a minimum 250 Ω loop impedance. A 250 Ω shunt resistor can be used together with the voltage divider board (GR2000/0375) to meet this requirement. In such cases the input should be programmed for 1 to 5V.

Standard Analog Input Modules

Linear Inputs	Standard Analog Input	Accuracy (% of Reading)
Millivolts	0 to 2000mV	0.1% or $\pm 10\mu$ V
Milliamps	0 to 50mA	0.2% or $\pm 2\mu$ A
Volts	0 to +20V*	0.2% or ± 2 mV
Resistance Ω	0 to 5000 Ω	0.2% or $\pm 0.08\Omega$
Sample Interval	100ms per sample (all modules are processed in parallel) gives worst case update times as follows: 600ms for 6, 12, 18, 24, 30, 36 channels mV, mA, voltage 800ms for 6, 12, 18, 24, 30, 36 channels THC 1100ms for 6, 12, 18, 24, 30, 36 channels resistance, RTD	
Input Isolation	12.5V DC channel-to-channel	
Isolation from Rest of Instrument	Galvanically isolated to 500V DC	

*Requires external voltage divider board (part no. GR2000/0375)

Analog Input Types

Thermocouple	Maximum Range $^{\circ}$ C	Maximum Range $^{\circ}$ F	Accuracy (% of reading)
B	-18 to 1800	0 to 3270	0.1% or $\pm 2^{\circ}$ C (3.6 $^{\circ}$ F) (above 200 $^{\circ}$ C [392 $^{\circ}$ F])
E	-100 to 900	-140 to 1650	0.1% or $\pm 0.5^{\circ}$ C (0.9 $^{\circ}$ F)
J	-100 to 900	-140 to 1650	0.1% or $\pm 0.5^{\circ}$ C (0.9 $^{\circ}$ F)
K	-100 to 1300	-140 to 2350	0.1% or $\pm 0.5^{\circ}$ C (0.9 $^{\circ}$ F)
L	-100 to 900	-140 to 1650	0.1% or $\pm 1.5^{\circ}$ C (2.7 $^{\circ}$ F)
N	-1200 to 1300	-325 to 2350	0.1% or $\pm 0.5^{\circ}$ C (0.9 $^{\circ}$ F)
R	-18 to 1700	0 to 3000	0.1% or $\pm 1^{\circ}$ C (1.8 $^{\circ}$ F) (above 300 $^{\circ}$ C [540 $^{\circ}$ F])
S	-18 to 1700	0 to 3000	0.1% or $\pm 1^{\circ}$ C (1.8 $^{\circ}$ F) (above 200 $^{\circ}$ C [392 $^{\circ}$ F])
T	-250 to 300	-400 to 550	0.1% or $\pm 0.5^{\circ}$ C (0.9 $^{\circ}$ F)
RTD	Maximum Range $^{\circ}$ C	Maximum Range $^{\circ}$ F	Accuracy (% of reading)
PT100	-200 to 600	-325 to 1100	0.1% or $\pm 0.5^{\circ}$ C (0.9 $^{\circ}$ F)



...Specification

2-wire Transmitter Power Supply

Number

1 fitted as standard

Voltage

24V DC

Drive

Up to 45mA, i.e. can drive 2 loops

Ethernet

Physical medium

10BaseT

Protocols

TCP/IP, ARP, ICMP, FTP (server), HTTP

FTP server functions

Directory selection & listing

File upload/download

12 configurable users with full or read-only access

Web server functions

Operator screen monitoring/selection. Remote monitoring of recording channels, analog/digital signals, alarms, totalizers and archiving

Advanced Math

Math Blocks

Type

12 equations provide ability to perform general arithmetic calculations including F_0 , mass flow, relative humidity and emissions calculations

Size

40-character equation

Functions

+, -, /, log, Ln., Exp, X^n , $\sqrt{\quad}$, Sin, Cos, Tan, mean, rolling average, standard deviation, high/median/low select, multiplexer, absolute, relative humidity

Tags

8- and 20-character tags for each block

Update rate

1 enabled block every 100ms

Logic Equations

Number

12

Size

11 elements each

Functions

AND, OR, NAND, NOR, XOR, NOT

Tags

20-character tag for each equation

Update rate

300ms



Modules

3- or 6-Relay Output Modules (max. of 4 Modules)

Number of relays

3 or 6 per module, max. of 4 modules (24 relays)

Type and rating

Relay type	single-pole changeover	
Voltage	250V AC	30V DC
Current	5A AC	5A DC
Loading (non-inductive)	1250VA	150W

Note. The total load for all relays within the instrument must not exceed 36A.

Hybrid Module (max. of 4 Modules)

Digital I/O

Number	6 inputs and 6 outputs per card
Type	Volt-free switching inputs
Polarity	Negative, i.e. closed switch contact or 0V = active signal
Digital input min. pulse	125ms
Digital output voltage	5V
Isolation	500V DC from any other I/O

Analog output

Number	2 isolated
Configurable current range	0 to 20mA
Max. load	750Ω
Isolation	500V DC from any other I/O

2-wire Transmitter Power Supply Module (max. of 2 Modules)

Number

2 isolated supplies per module

Voltage

24V DC nominal

Drive

45mA per supply, i.e. each module can drive 2 x 2 = 4 loops

RS485 Serial Communications Module (Max. of 1 Module)

Number of ports

1

Connections

RS485, 2- or 4-wire

Protocol

Modbus RTU slave



...Specification

EMC

Emissions & immunity

Meets requirements of:
EN50081-2
EN50082-2
EN61326 for an industrial environment

Electrical

Power supply

90V min. to 265V max. AC 50/60Hz
24V DC \pm 2.4V (optional, pending)

Power consumption

35VA max

Power interruption protection

No effect for interruptions of up to 20ms

Safety

General safety

EN61010-1
Overvoltage Class III on mains, Class II on inputs and outputs
Pollution category 2

Isolation

500V DC to earth (ground)

Environmental

Operating temperature range

0 to 50°C (32 to 122°F) with SmartMedia/Compact Flash

Operating humidity range

5 to 95%RH (non-condensing)

Storage temperature range

-20 to 60°C (-4 to 140°F)

Front panel sealing

IP66 and NEMA4X

Rear panel sealing

(with rear cover) IP40
(without rear cover) IP20

Physical

Size

288mm (11.34in.) x 288mm (11.34in.) x 195mm (7.68 in.)
(depth behind panel)

Weight

8kg (17.64 lb) approx. (unpacked)

Panel cutout

281mm (11.06 in.) x 281mm (11.06 in.)

Case material

20% glass-filled polyester/stainless steel (grade 304)

Display housing material

25% glass-filled polyester

Screen

Double layer polyester coated toughened glass



Electrical Connections

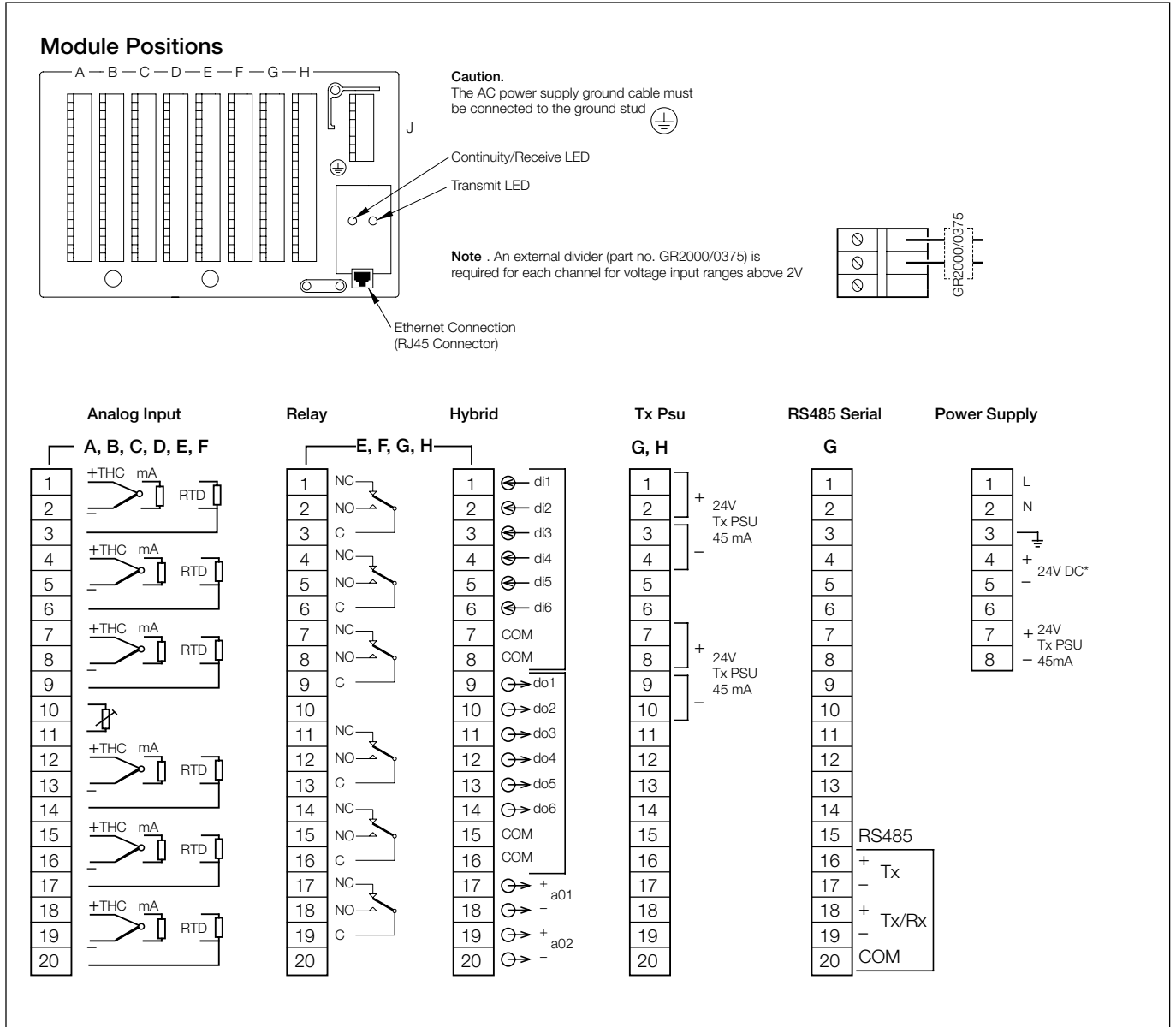

*Note. 24V DC instrument power supply must be specified when ordering.



Overall Dimensions

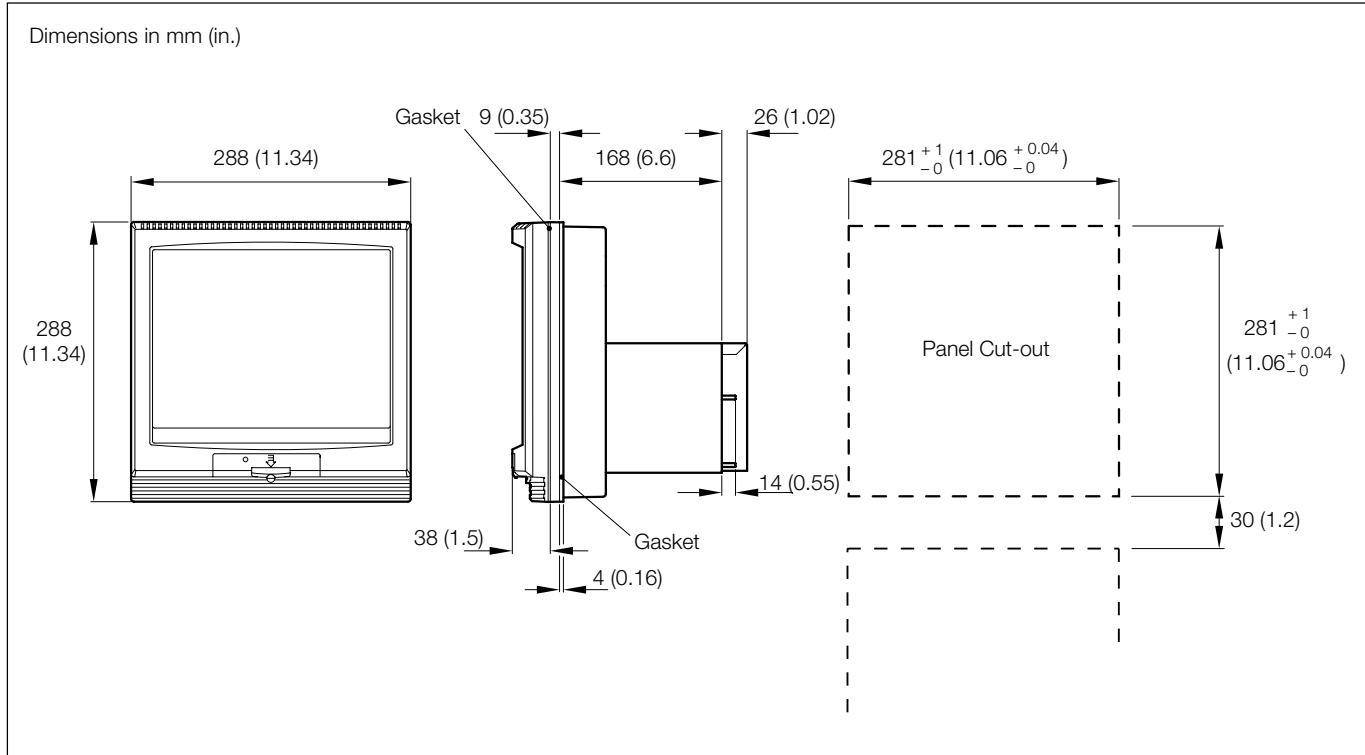

Optional Accessories

Part No. **Description**

SmartMedia Cards

B11860	SmartMedia Card (16Mb)
B11861	SmartMedia Card (32Mb)
B11862	SmartMedia Card (64Mb)
B11863	SmartMedia Card (128Mb)

Compact Flash Cards

B11864	Compact Flash Card (16Mb)
B11865	Compact Flash Card (32Mb)
B11866	Compact Flash Card (64Mb)
B11867	Compact Flash Card (128Mb)

Card Reader

B11826	SmartMedia-to-3 1/2 inch Floppy Disk Drive Adapter
B11827	Compact Flash Reader (parallel port interface)
B12031	Combined SmartMedia & Compact Flash (USB Interface)*

Other

GR2000/0375	Voltage divider board (2 to 20V) – per voltage input channel
SW/DATMGR	DataManager Software

* Compatible with Windows 98/98se, ME, 2000 & XP

Licensing, Trademarks and Copyrights

Windows™ is a trademark of the Microsoft Corp.
Modbus™ is a trademark of Modicon, Inc.

Ordering Information

Multipoint Videographic Recorder	SM30	XX	X	X	X	X	X	X	X	X	X	X	X	X	X	X	X	X	XXX
Analog Inputs																			
None		00																	
6 inputs		06																	
12 inputs		12																	
18 inputs		18																	
24 inputs		24																	
30 inputs		30																	
36 inputs		36																	
Standard Universal Inputs																			
			S																
Build Option																			
Standard				B															
cCSAus (pending*)				C															
Archive Media																			
None – (8Mb internal flash memory only)						0													
SmartMedia drive						1													
Compact flash drive						2													
Software Option																			
None						0													
Advanced Math						1													
Option Modules																			
Position A	Reserved for analog inputs					0													
Position B	Reserved for analog inputs						0												
Position C	Reserved for analog inputs							0											
Position D	Reserved for analog inputs								0										
Position E	None (only option available if 30 or more analog inputs)									0									
	3 relays									3									
	6 relays									6									
	Hybrid									H									
Position F	None (only option available if 36 or more analog inputs)										0								
	3 relays										3								
	6 relays										6								
	Hybrid										H								
Position G	None											0							
	3 relays											3							
	6 relays											6							
	Hybrid											H							
	2-wire transmitter power supply												T						
	RS485 serial communications												S						
Position H	None													0					
	3 relays													3					
	6 relays													6					
	Hybrid													H					
	2-wire transmitter power supply													T					
Mechanical Build																			
Without rear terminal cover																		1	
With rear terminal cover																		2	
Power Supply																			
90V min. to 265V max. AC																			2
24V DC (pending*)																			3
Language																			
English																			E
French (pending*)																			F
German (pending*)																			D
Italian (pending*)																			I
Spanish (pending*)																			S
Special Features																			
Standard																			STD
Custom configuration																			CUS

* For more information contact your local Sales Office.



ABB has Sales & Customer Support
expertise in over 100 countries worldwide

The Company's policy is one of continuous product
improvement and the right is reserved to modify the
information contained herein without notice.

Printed in UK (09.03)

© ABB 2003

ABB

Distributed by



PO Box 1 • Ilkley • West Yorkshire • LS29 8EU
Phone: 01943 602001 • Fax: 01943 816796
Website: www.issltd.co.uk • Email: sales@issltd.co.uk

instrumentation
Systems & Services Ltd

