

100mm Advanced Process Recorder

SR100A

Industrial^{IT}
enabled™

PO Box 1 • Ilkley • West Yorkshire • LS29 8EU
Phone: 01943 602001 • Fax: 01943 816796
Website: www.issltd.co.uk • Email: sales@issltd.co.uk

instrumentation
Systems & Services Ltd

- **1- to 6-trace recording on a 100mm chart**
 - continuous intelligent traces on a common time base
- **Precision universal process inputs**
 - accepts thermocouples, RTDs, mA, mV and V
- **Unique Cue and Review incident analysis**
 - historical data at the touch of a button
- **High clarity LCD display**
 - clear message display and text prompts
- **Totalizers, math and logic equations**
 - advanced processing capabilities, soft wiring for extended functionality
- **RS485 Modbus™ serial communications**
 - provides full integration with your control system
- **Dust and water resistant to IP65 (NEMA3) front fascia**
 - for hosedown industrial environments
- **Direct configuration and logging on PC**
 - dedicated configuration software, datalogging to memory card



SR100A – simplicity with power

PO Box 1 • Ilkley • West Yorkshire • LS29 8EU
Phone: 01943 602001 • Fax: 01943 816796
Website: www.issltd.co.uk • Email: sales@issltd.co.uk

instrumentation
Systems & Services Ltd

ABB

SR100A

The SR100A is a 100mm strip chart recorder providing accurate and reliable recording of up to 6 channels. The SR100A also provides a range of advanced processing capabilities, such as flow totalization, math blocks, logic equations, configurable displays and full message printing, which can be configured via the front panel facia or PC Configurator software.

When fitted with the optional PC memory card data storage, RS485 Modbus communication and up to 12 alarm relays, the recorder becomes a very powerful signal processing tool.

To assist the operator in analyzing any process problem, the SR100A has a unique patented Cue-and-Review system, allowing the user to examine historical data anywhere on the chart at the push of a button.

The SR100A can be supplied either for panel mounting or for portable use. The front facia, rated IP65 (NEMA3), is resistant to hosedown and dusty environments.

Application areas include:

- Furnaces
- Water treatment plants
- Cold stores
- Stack gas monitoring
- Sterilizer surveys
- Laboratories

Process Connections

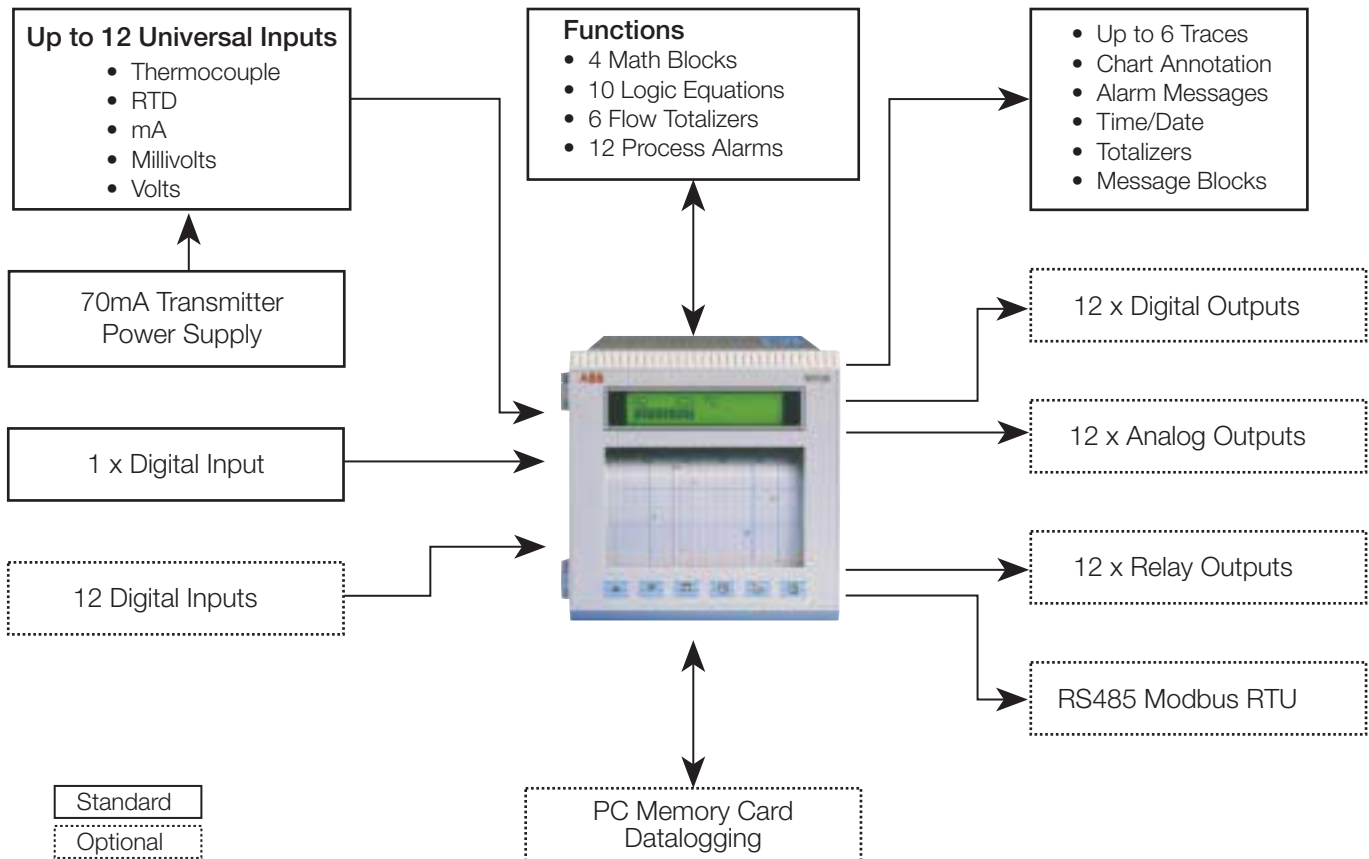

Operation

A graphic liquid crystal display (LCD) provides a choice of five different display formats to suit the application.

During normal operation the display cycles through each channel in sequence.

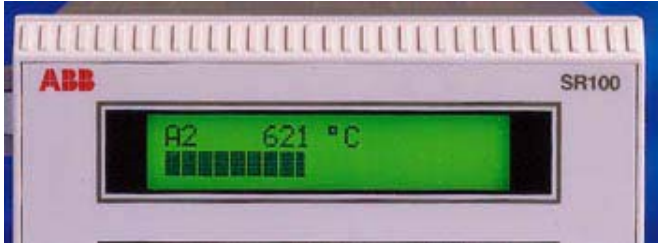

Clear text prompts on the display assist the operator in accessing functions such as chart reload and alarm acknowledge using membrane keys on the front of the recorder.

Password protection prevents unauthorized access to the recorder's configuration.

Quickly-fitted pen cartridges and an easily-removable chart cassette ensure simple and efficient pen and chart replacement.



Unique Post-Incident Analysis (Cue and Review)

The SR100A allows the user to quickly rewind to any part of the roll chart for process event or alarm occurrence – enabling rapid and accurate analysis of process records.

The SR100A can be configured to monitor up to 12 user-defined process alarms and two real-time clock alarms.

The 10 most recent alarms are held in a buffer, allowing the user to examine the order of process incidents and to review that part of the chart for analysis and evaluation.

Set-up

The SR100A can be easily set up to match your process in either of two ways:

Keypad – for small changes the simplest method is by means of the keypad on the front of the unit. Entry of the correct password gives access to the recorder's configuration. A simple menu structure with clear text descriptions provides an intuitive approach to the recorder set-up.

PC Configurator – the fastest way to set up SR100A recorders is by means of the PC Configurator software. This Windows™-based package provides a simple 'point-and-click' approach to generating a full recorder configuration off-line. The completed configuration can be printed out or saved onto disk before being downloaded to the recorder.

An interface cable is used to provide the connection between the PC's serial port and the configuration port on the recorder.

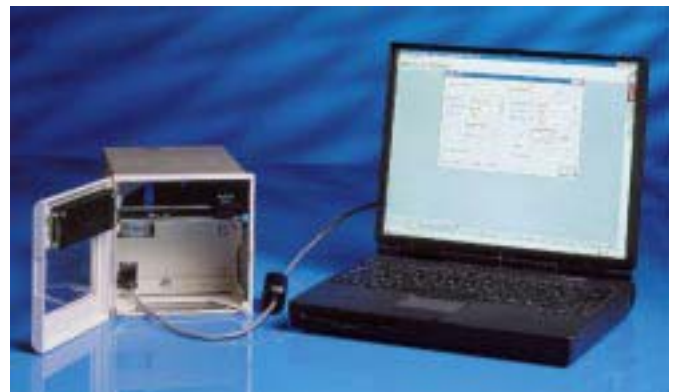

Recording

The SR100A's high-speed multi-point printing system updates all 6 traces in 800ms. This system produces continuous lines on the chart for speeds of up to 500mm/hr.

The printing sequence is intelligently managed by the recorder's control system to give priority to fast-changing signals or events, ensuring the most comprehensive process record is traced on the chart.

The SR100A supports full text printing to provide detailed annotation on the chart. In addition to the time, date, channel identity and chart speed, the recorder can print scales for each channel, alarm messages, totalizer values and an operator-defined batch name.

The 'Easy-view' facility enables the user to see the latest recordings at the push of a button.

Chart Annotation

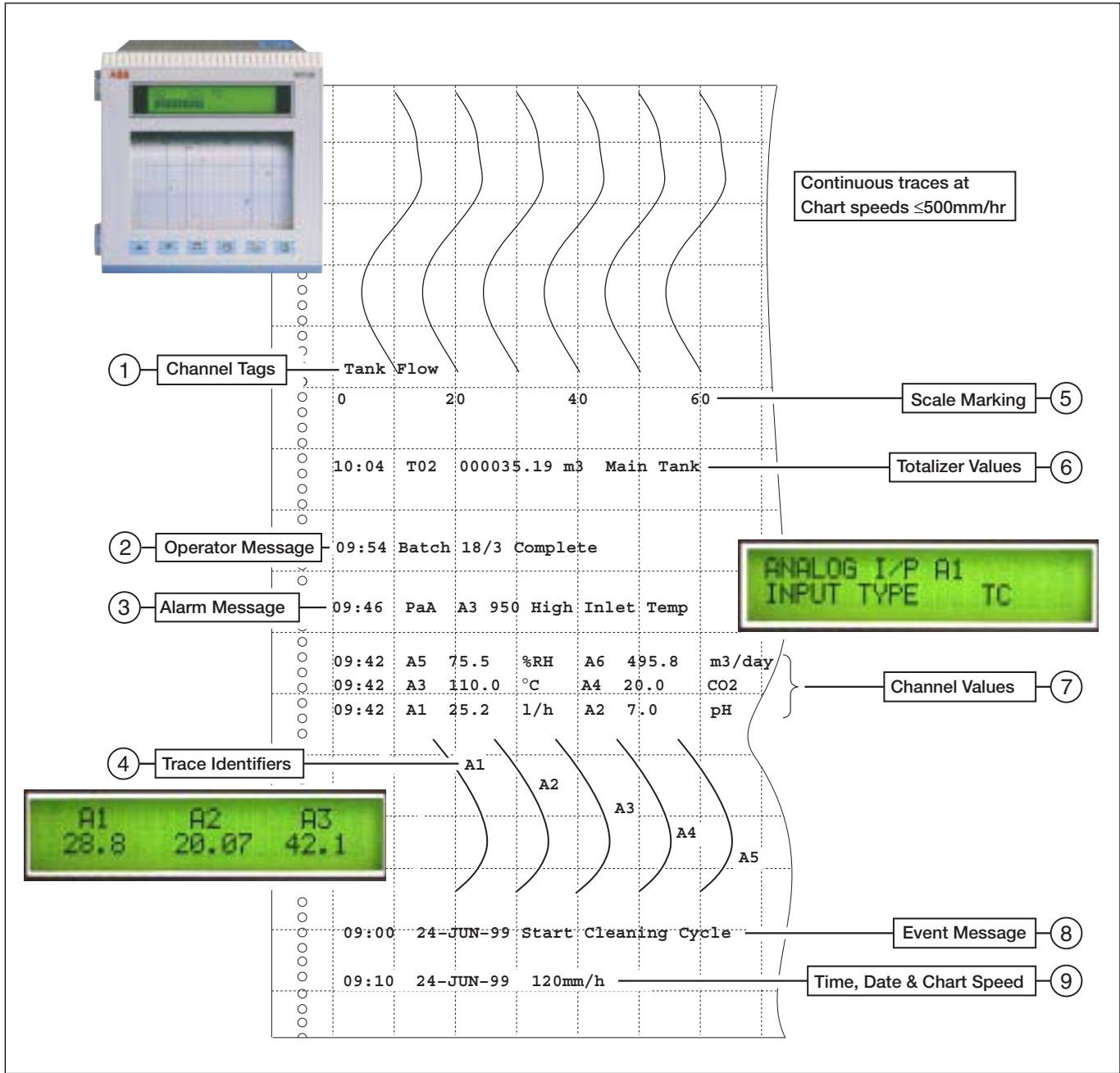

- ① **Channel Tags** – printed before chart scale to identify each channel
- ② **Operator Message** – batch identification printed on demand from a digital signal or via the front panel keys.

③ **Alarm Message**

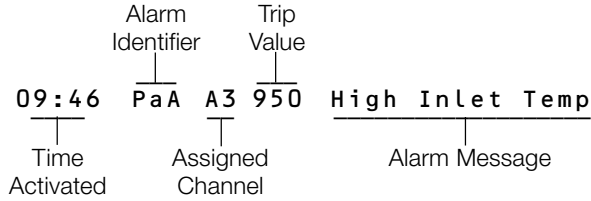

- ④ **Trace Identifiers** – one identifier per trace.
- ⑤ **Scale Marking** – one scale per trace, printed across the width of the zone, at intervals of 20 to 240mm.

⑥ **Totalizer Values** – printed at programmable intervals (between 5 minutes and 24 hours).

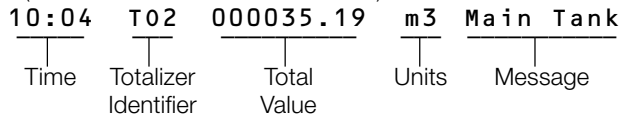

⑦ **Channel Values** – block of instrument channel values printed at intervals (time or digital).

⑧ **Event Message** – printed on demand from a digital signal or via the front panel keys.

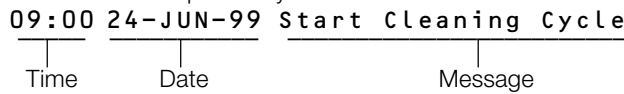

⑨ **Time, Date & Chart Speed** – printed on power-up and at 240mm intervals (approx.). The time is printed every 60mm (approx.).

Data Storage on Memory Card

The optional memory card facility provides full data logging capability and enhanced configuration security on the SR100A.

The SR100A can serve as a fully-fledged 12-channel data logger, providing a simple method of channelling analog measurements to a PC.

Up to 12 process signals or math channels can be logged to the memory card, along with associated time stamp, tag information and process alarms. Data can be directly imported to spreadsheet packages for detailed analysis or copied onto disk for later use.

Process and configuration data can be electronically stored on removable PCMCIA SRAM memory cards of up to 4Mb capacity. Data held in the memory card is transferred to a PC via an external card reader or via a built-in PCMCIA slot. Stored information is held in DOS format files allowing direct transfer to/from a PC disk using DOS or Windows file management commands.



Configuration Storage

Instrument configuration can be stored via the PC software or saved on the PC memory card which can be quickly downloaded into another SR100.



Modbus Serial Communications

The RS485 serial communications link enables the SR100A to interface with SCADA systems, PLCs or plant-wide data gathering networks.

All process information can be read over the link in real time by a host computer using Modbus RTU communications protocol.

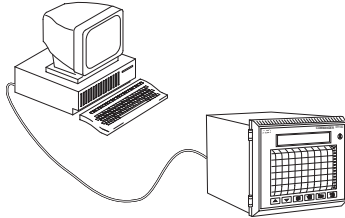

Option Modules

All recorders are complete with at least one universal input module for analog process signals, plus a transmitter power supply for up to three 4 to 20 mA devices.

The capabilities of your recorder can be extended further by the addition of option modules. Each recorder can support 12 inputs plus up to 6 option modules.

Type	Standard	Option
Universal Inputs	1 – 6	–
Additional Analog Inputs	0	3 – 6
Relay	0	12
Transmitter Power Supply	3	0
Serial Communications	X	✓
Digital Inputs	1	12
Digital Outputs	0	12
Analog Outputs	0	12

Innovative Design

Mechanical and electrical component count is minimized for improved performance and reliability.

An advanced analog/digital design ensures long term stability and allows range changes to be made without the need for recalibration.

Exceptional immunity to RF interference, electrical noise and line dropout (brown-out) conditions, together with the IP65 (NEMA 3) rated front face, ensure reliable operation – even in harsh industrial environments.

Long life, plug-in print cartridges with 25m roll or 12m fanfold charts, both with quick-loading cassettes, and speeds from 1 to 1500mm/hr ensures minimal operating costs.

Built-in Quality

The SR100A is designed, manufactured and tested to the highest quality standards, including ISO 9001, CSA and UL. We also have environmental accreditation to ISO 14001.

Applications

Mass Flow

In a number of processes, such as combustion fuel control, reactor recipe formulation and many more, there is a need to compensate for variations in temperature and pressure to enable the process to be controlled and monitored in compensated units, e.g. Mass. This applies throughout many industries such as Mining, Food, Pulp/Paper, Pharmaceutical and Chemical.

The SR100A has, as standard, up to 4 math blocks which have standard templates for Mass Flow and the ability to build your own calculations.

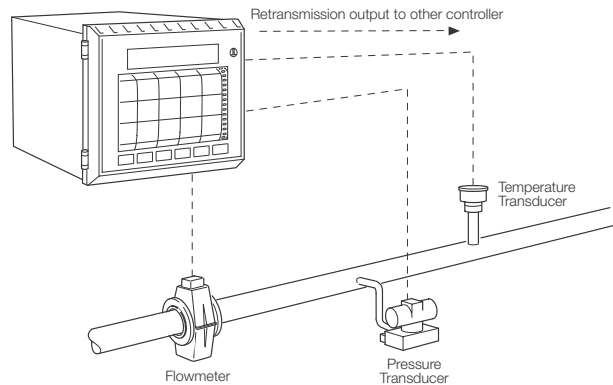

Temperature Recording

Recording of temperature is common in a wide range of industries, such as Aerospace, Car Component, Food, Chemical and Kiln/Ovens, using both direct-connected thermocouples and RTDs or 2-wire field-mounted transmitters.

The SR100A can accept direct connection to all standard thermocouples, Pt100 and 4/20mA transmitters and record on up to 6 channels or datalog up to 12 inputs.

Operator messages also allow printing of configurable messages such as 'Start of Test' or 'Cycle Complete' for a clear record of the batch.

For electric ovens fit the 500V isolator card to avoid conductance on the thermocouple which causes 'noise' on the chart.

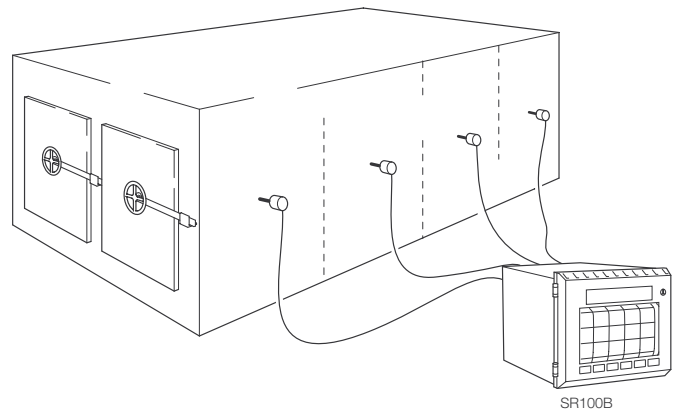

DataLogging

The ability to datalog information and transfer it to a PC in a spreadsheet format is now becoming an extremely powerful tool in a great number of industries. The ease of storing and transferring the information that this gives allows the user to undertake complex cross-correlation of trends easily on a PC.

The SR100A, as an option, has a PCMCIA port for logging up to 12 inputs in a DOS format, which can be directly imported into an Excel™ spreadsheet.

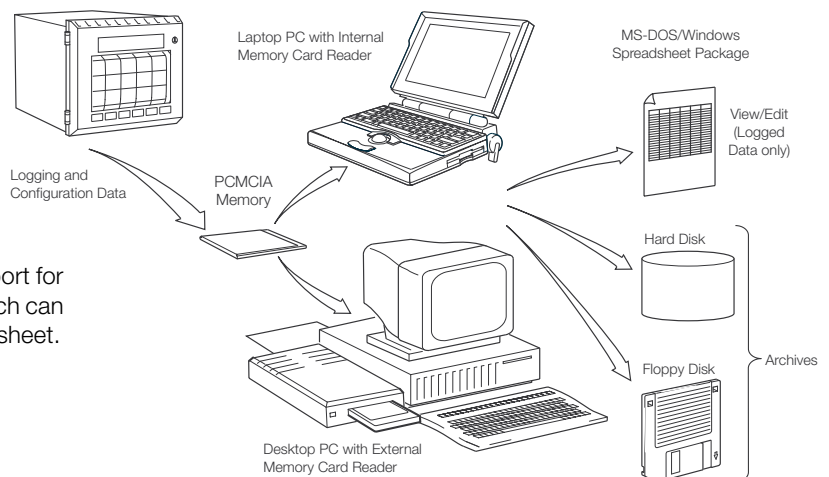

...Applications

Environmental Monitoring

The monitoring and control of emissions into the atmosphere from chimneys, gas stacks etc., in particular carbon dioxide, carbon monoxide, hydrogen and Smoke Density, is becoming a statutory requirement in most countries.

The SR100A is ideal for these applications as it can trace up to 6 different input types with time and date stamps and logs a further 6 more inputs if required.

The IP65/NEMA3 rating of the SR100A allows it to be mounted in a control room or an outdoor enclosure.

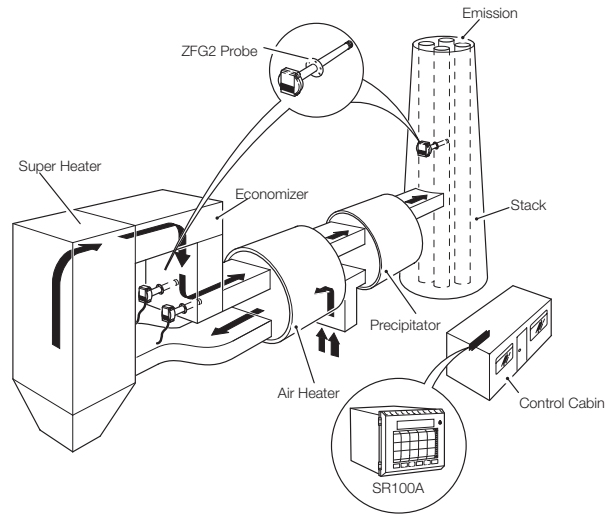

Waste Monitoring and Control

The discharge of effluent into rivers and streams is very tightly controlled and the requirement to be able to prove that the regulations have been met is extremely important. The simplest way is to use a chart recorder connected to the pH transmitter in the discharge line.

Flow rates can also be monitored with the added advantage of having multiple totalization.

One totalizer may be a continuous, non-resettable, total whereas another of the six available can be a weekly, resettable, total.

Totals can be printed on the chart along with the time, date and alarm conditions.

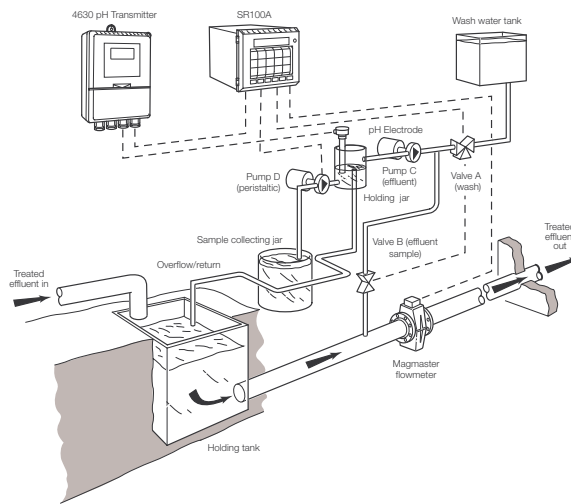

Temperature Monitoring and Alarms

The monitoring of Cold Stores and Temperature-controlled Rooms is essential in food production to ensure that the user has a record that all of the goods produced were stored at the correct temperature, ensuring that they are free from contamination.

The simplest and easiest way to do this is with the SR100A strip chart recorder, which can take up to 6 inputs from RTDs spread across a cold store or a number of food preparation areas.

At a chart speed of 20mm/hour the unit provides recording for one month, as well as alarm functions, when fitted with relay output modules.

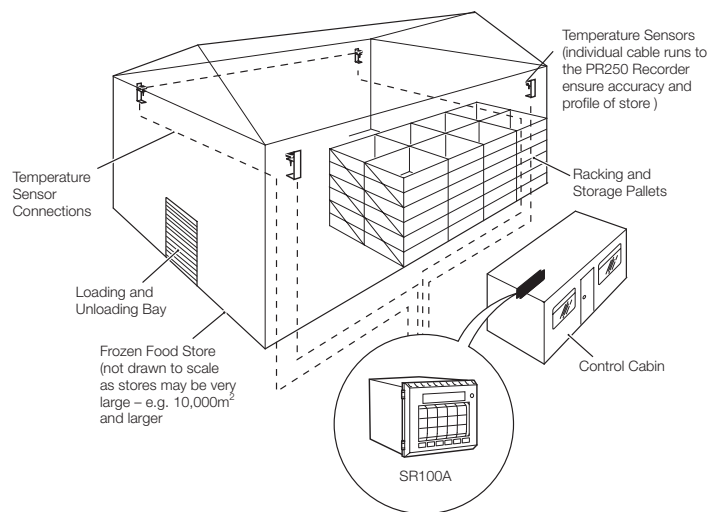

Application Function Overview



Up to 12 process alarms can be set-up within the recorder. The alarms can be used to operate relay outputs, print messages on the chart or change the chart speed.

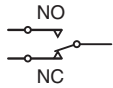

A maximum of 12 relays can be fitted within the recorder for use as alarm outputs. A single common relay can be set up to be triggered by multiple alarms.



Up to 13 digital inputs can be fitted for remote changing of chart speed, alarm acknowledgment, input to logic equations and event recording.

15480970

The SR100A includes, as standard, 6 independent flow totalizers. These can be programmed to count up or down, with end of batch alarm if required.



Internal soft wiring of functions using 10 logic equations minimizes installation costs and maximizes functionality.

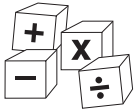

There are 4 math blocks available, each with up to 3 inputs. Also included are preset math blocks for mass flow, %RH, max., min. and average calculations.

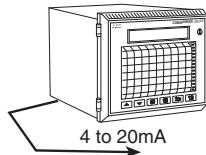

12 analog outputs can be fitted for retransmission of any input signal or math function result.

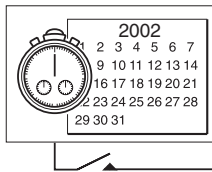

Two event timers can be set to activate hourly, daily or weekly and can be used in logic equations.

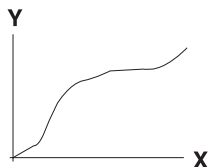

Included as standard is a 20-breakpoint custom linearizer for use in non-standard thermocouples, tank level or other unusual input ranges.

Specification

Summary

1, 2, 3, 4, 5 or 6 traces
100mm wide roll or fan-fold chart
Fully user-programmable
IP65/NEMA3 protection
PC configuration

Chart

Traces

1 through 6 multicolor or digital data recording

Colors

Single trace	Red
Two traces	Pen 1 = Red, Pen 2 = Green
Three traces	Pen 1 = Red, Pen 2 = Green, Pen 3 = Blue
Four to six traces	per DIN standard

Pen life

4 months (typical)

Chart

12m fanfold or 25m roll
Quick-load cassette
Cue-and-review feature standard with roll chart
Standard chart graduation 50 divisions
30, 40, 60, 70, 75
divisions also available

Chart speed

Configurable in 1mm steps between 1 and 1500mm/hr
Logic or switch selectable at three configured speeds

Trace response

800ms for update of six traces

Operation

Display

Alphanumeric and bargraph
2 x 20-character long-life back-lit LCD
100 segment bargraph

Languages

English, French, German user-selectable

Configuration

User-defined via front panel, 'Memory Card' or PC Configurator

Advanced Processing Functions

Totalizers

Six independent, with configurable wraparound,
digital/manual reset and stop/start

Text messages

14 configurable messages (20-character)
assignable to any digital or alarm function
12 analog input channel tags (20-character)
4 math result tags (20-character)
6 totalizer descriptions (8-character)
1 operator message for batch identification (20-character)

Alarms

12 user-defined, system events and diagnostic alarms
2 real-time events

Math functions

Four user-configurable functions, each with three inputs,
for evaluation of one of 8 standard arithmetic functions
or for standard calculations for mass flow or %RH

Logic functions

10 logic equations, user-defined up to 15 elements per equation
(AND, OR)



Analog Inputs

Number

- 1, 2, 3, 4, 5 or 6 Standard Analog Inputs
- 2, 3 or 6 Isolated Analog Inputs
- 3 or 6 additional channels available (Option B)

Input sampling rate

180ms per channel

Type

Universally configurable to provide:

- Thermocouple (THC)
- Resistance thermometer (RTD)*
- Millivolt
- Current
- DC voltage*
- Resistance*

Linearizer functions

Programmable for all inputs including: $\sqrt{\quad}$, $x^{3/2}$, $x^{5/2}$
 THC types B, E, J, K, R, S, T, L, N, or Pt100*
 20-point custom linearizer

Broken sensor detection

Programmable UP/DOWN scale or NONE
 RTD short/open circuit detection*

Cold junction compensation

Automatic CJC incorporated as standard

Input impedance

Current 10 Ω
 DC voltage 500k Ω
 mV & THC >10M Ω

Transmitter power supply

70mA max. powers three loops, fitted as standard

Input Isolation

Standard Input Module

Analog channel-to-channel 12V (0V with RTDs)
 Input to ground 500V DC dielectric strength
 Common mode >140dB at 50/60Hz with 500 Ω imbalance resistance.
 Series mode >60dB at 50/60Hz
 Filtering 0 to 60s 'Smart' digital filter.

500V Input Module

Analog channel-to-channel isolation 500V DC dielectric strength
 Input to ground 500V DC dielectric strength
 Common mode >140dB at 50/60Hz with 500 Ω imbalance
 Series mode >60dB at 50/60Hz
 Filtering 0 to 60s 'Smart' digital filter

*RTD, Resistance and Volts (>2V) inputs not available on Isolated Analog Inputs

Input Temperature Limits

THC /RTD Type	°C			°F		
	Min.	Max.	Min. Span	Min.	Max.	Min. Span
Type B	-18	1800	710	0	3272	1278
Type E	-100	900	45	-148	1652	81
Type J	-100	900	50	-148	1652	90
Type K	-100	1300	65	-148	2372	117
Type L	-100	900	50	-148	1652	90
Type N	-200	1300	90	-328	2372	162
Type R & S	-18	1700	320	0	3092	576
Type T	-250	300	60	-418	572	108

Performance accuracy is not guaranteed below 400°C (752°F) for types B, R and S thermocouples.

Min. span below zero: Type T 70°C/126°F
 Type N 105°C/189°F

THC standards DIN 43710 (IEC 584)

RTD	Min.	Max.	Min. Span	Min.	Max.	Min. Span
	-200	600	25	-328	1112	45

3-wire platinum, 100 Ω per DIN 43760 standard (IEC751), with range of 0 to 400 Ω .

RTD standards DIN 43760 (IEC 751)

Electrical Limits

Input Type	Min. Value	Max. Value	Min. Span
Millivolts	-2000	2000	2.5
Volts	-20	20	0.25
Milliamps	-100	100	0.25
Resistance	0	8000	10



...Specification

Accuracy

Pen

Resolution 0.2% of span

Display

Intrinsic error for reference conditions, 20°C

mV Inputs 0.1% of reading $\pm 10\mu\text{V}$

THC Inputs as mV equivalent plus linearizer error

CJC $< 0.05^\circ\text{C}/^\circ\text{C}$ change in ambient

mA, V Inputs 0.2% of reading or $\pm 2\mu\text{A}$

RTD Inputs $< \pm 0.2\%$ of reading or $\pm 0.5^\circ\text{C}$

Channel-to-Channel Offset $< 20\mu\text{V}$ or $< 0.025\Omega$ without using individual channel offset correction

Engineering Range -999 to $+9999$.

Display Resolution for spans > 4000 – ± 2 digits
for spans < 4000 – ± 1 digit.

Long Term Drift $< 0.01\%$ reading, or
 $< \pm 5\mu\text{V}$ annually

Environmental

Operating limits

5 to 50°C (41 to 122°F),
95%RH non-condensing
80%RH for chart

Temperature stability

0.02% of reading/ $^\circ\text{C}$, or $2\mu\text{V}/^\circ\text{C}$ whichever is greater

Protection

Front face IP65/NEMA 3

Rear of instrument IP20

Line interruption

$< 80\text{ms}$ loss, no effect

$> 80\text{ms}$ loss, auto-reset and restart

IEC Part IV level 3

Electromagnetic capability

EN 50081-2

EN50082-2

CE Marked

Physical

Size

144mm (5.67 in.) x 144mm (5.67 in.)
x 230mm (9.05 in.) (depth behind panel)

Weight

3.3kg (7¹/₄ lbs.) approx.

Panel cut-out

138mm (5.43 in.) x 138mm (5.43 in.)

Case material

Stainless steel

Door material

Glass-filled polycarbonate

Window material

Polycarbonate

Electrical

Power supply

85 to 265V 50/60Hz
or 10V to 30V DC
or 24V AC

Power consumption

25VA max.
20W DC (typical)

Electrical safety

EN61010-1
CE Marked instruments meet EU regulations
CSA (optional)

Electrical connections

Screw terminals

EMC

Design & manufacturing standards

CSA General Safety Approved

UL General Safety Approved



Option Modules

Up to six modules can be fitted from the following:

Additional analog input module

Three or six inputs on the module
(Code Options B & C) *

Universally configurable for all input types

12V channel-to-channel isolation

* See **Ordering Information**

Digital module

Three digital inputs plus three digital outputs per module

Fully isolated, 500V DC

Input Volt-free contact or 5V DC level triggered

Output True TTL (15k Ω load)
5V or 24V DC (20mA per output)

Relay output module

Three relays per module

Type single pole changeover

Rating 250V AC 5A (non-inductive load)
250V DC 25W maximum

Total load (all relays) 36A max.

Hybrid module

Two relay outputs (specification as above)

One isolated analog output, configurable in range 0 to 20mA into
1000 Ω max. load, isolation 500V DC

Analog output module

Three isolated retransmission channels per module
(configurable in range 0 to 20mA, 1000 Ω)

Isolation 500V DC

Each channel can be programmed to retransmit any analog value
or result of math block calculation

Accuracy $\pm 0.25\%$ of span

Serial communication module

RS422/485 protocol programmable 1200 to 9600 baud

Modbus RTU (slave) protocol

Memory card

PCMCIA/SRAM 'credit card' type

Card sizes 64kb, 512kb, 1Mb, 2Mb, 4Mb

Configuration storage DOS format files

Configuration capacity 15 configurations on a 64kb card

Data logging format DOS files, spreadsheet compatible

Channels logged Up to 12 (analog inputs or math)

Sample interval 1s to 240s (user-defined)

Card capacity 25 days (approx.) on a 2Mb card,
for 6 channels logged every 60s



Accessories

Memory cards to PCMCIA 68 pin standard – see price list for options available (capacity 64k – 4Mb)
PC Configuration Kit (part no. C100/0700)

Licensing, Trademarks and Copyrights

MS Windows™ is a trademark of Microsoft Corporation
Modbus™ is a trademark of Modicon, Inc.

ABB has Sales & Customer Support expertise in over 100 countries worldwide

The Company's policy is one of continuous product improvement and the right is reserved to modify the information contained herein without notice.

Printed in UK (09.03)

© ABB 2003



Distributed by



PO Box 1 • Ilkley • West Yorkshire • LS29 8EU
Phone: 01943 602001 • Fax: 01943 816796
Website: www.issltd.co.uk • Email: sales@issltd.co.uk

Instrumentation
Systems & Services Ltd

